

FIRST FIX DIAGRAM

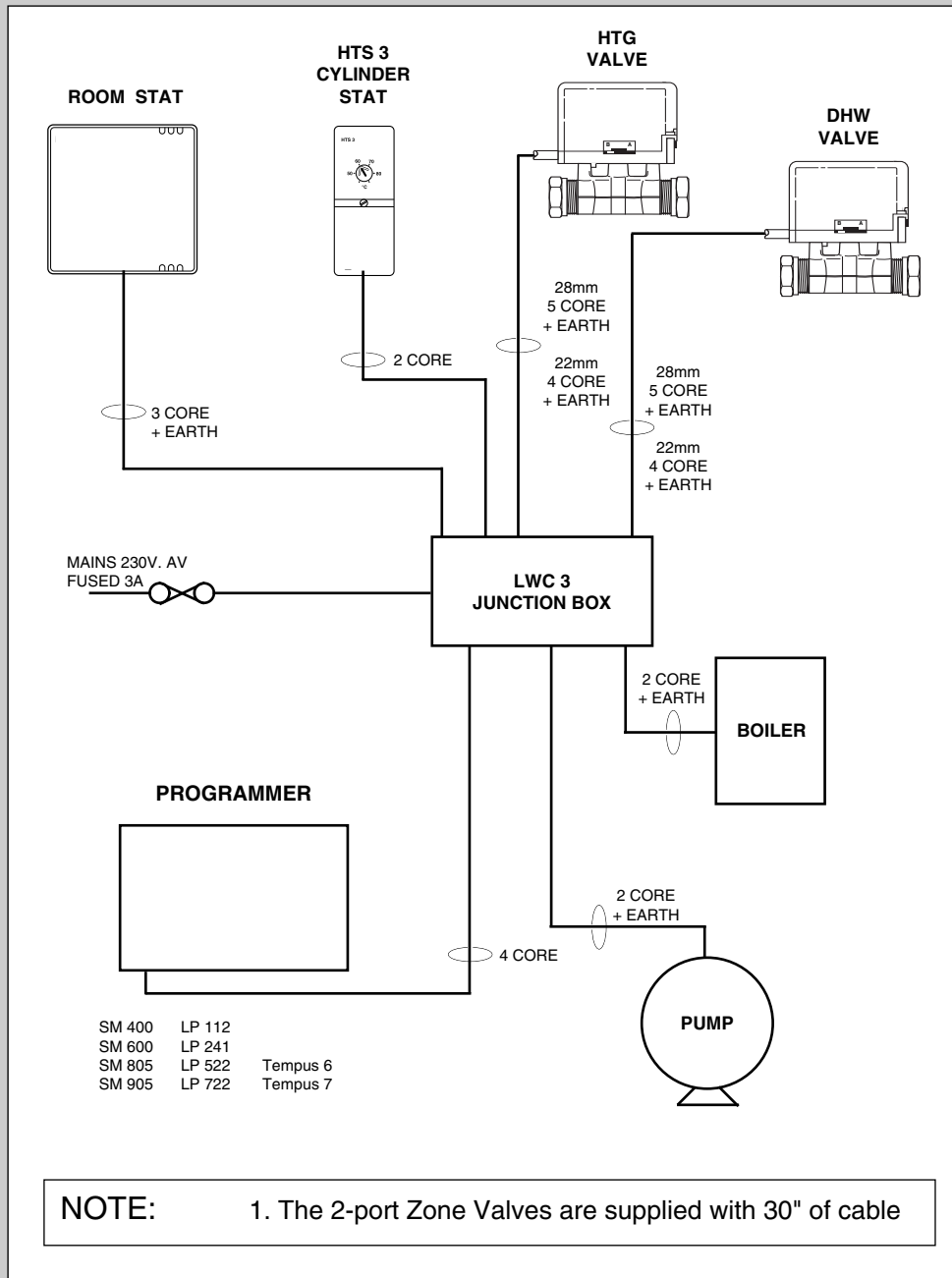

Lifestyle

Heating Control Pack

with
Switchmaster, Lifestyle or Tempus Programmer

**ZONE
VALVE PACK
WITH
OPTIONAL
JUNCTION
BOX**

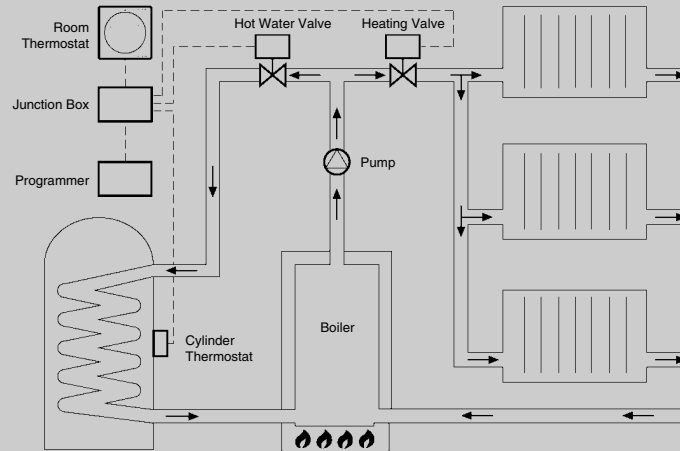

CONTENTS

- Programmer
- Zone Valve Heating
- Zone Valve Hot Water
- Room Thermostat
- Cylinder Thermostat
- Optional LWC3 Junction Box

INSTALLATION AND WIRING GUIDE

INSTALLATION INSTRUCTIONS

PROGRAMMER

Please refer to separate leaflet.

MOTORISED VALVE

Installation

Install the valve in a clean, dry location where the ambient temperature does not exceed 52°C. Ensure that the motor housing is not below the valve body. The manual lever and motor cover retaining-screw should be left accessible and the position indicator visible. Cut connecting copper tubes to allow 10-15mm penetration (22mm valve) or 22-25mm penetration (28mm valve) into the valve body, and ensure tube ends are square and free of burrs. Slip the compression nuts over the ends of the tubes, followed by the copper olives so that these fit within the threaded sections of the nuts. Offer up to the valve body, screw on and tighten the compression nuts by hand until finger tight and then tighten fully using suitable spanner or adjustable wrench. Care must be taken not to over tighten or to put any mechanical force on the plastic parts of the valve.

OPERATION

Lifestyle two port valves are supplied *normally* closed, ie. they have to be powered to open. They spring return to the closed position when the power is removed. Flow direction should be in through Port 'A' and out through Port 'B'.

MANUAL LEVER

The manual lever is used when filling, venting and draining the installation. To open the valve, the manual lever should be moved from left to right across the valve and then pressed in. When released it will lock in this position. It automatically releases when power is applied to the valve.

VALVE POSITION INDICATOR

A = valve closed B = valve open

ROOM THERMOSTAT

Location

Care should be taken to mount the thermostat in a position which is not subject to direct sunlight or draughts. Preferably it should be fixed on an inside wall about 1.5m above the floor in a position where it can respond to room temperature but away from the direct influence of radiators or other appliances giving off heat.

Fixing

Remove the dial, undo the screw and lift off cover. Fix the base onto a flat wall or flush mounting single conduit box. If the patress is required, fix this first and then mount thermostat base using the screws supplied. Wire to terminals as shown in the diagram opposite.

IMPORTANT

This thermostat requires a neutral and must be earthed.

CYLINDER THERMOSTAT

Positioning

The HTS3 should be installed approximately one third of the way up the hot water cylinder, and at the front for ease of access. With pre-insulated cylinders, mark the position and size, and remove just enough insulation to allow the HTS3 to fit against the metal of the cylinder in the recess formed.

The base of the HTS3 should be held in good contact with the metal of the hot water cylinder.

The plastic covered spring fixing cable should be cut to an unstretched length of approximately 2 1/2" - 3" less than the circumference of the cylinder and the hook and eyelet screwed into the ends. Stretch the cable round the cylinder, above the insulation, and position it in the groove across the front of the HTS3. Engage the hook and eyelet.

Commissioning

The two setting marks outside the temperature scale on the HTS3 provide positive ON and OFF positions to assist with commissioning or checking the system operation. Rotate the setting arrow fully clockwise for ON, and anticlockwise for OFF.

Setting

With a screwdriver, position the setting arrow at the desired nominal hot water temperature. A popular setting is 60°C but if this is not exactly suitable, simply adjust up or down as appropriate.

Frost Protection

If frost protection is required, we recommend that a frost thermostat (RTS3) is fitted in series with a pipe thermostat (PTS1) to provide 'Two Stage' protection.

CONFORMS TO THE ESSENTIAL REQUIREMENTS OF THE FOLLOWING DIRECTIVES:
89/336/EEC - Electromagnetic compatibility; 73/23/EEC - Low Voltage Directive

See back of this leaflet for details on cable requirements for installation.

ZONE VALVE Systems with LWC1 Wiring Centre

LWC 3 Junction Box



CONNECTIONS

The numbers printed at the tip of each arrow represent the Junction Box Terminals to which those leads or terminals should be connected.

Pump

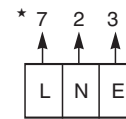

Boiler

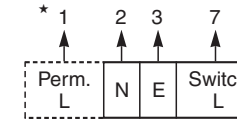

*Refer to Boiler Handbook for wiring details of Pump Overrun boilers. Use boiler manufacturers instructions.

Controls

Room Thermostat

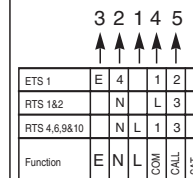

Cyl. Thermostat

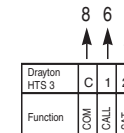

Programmer

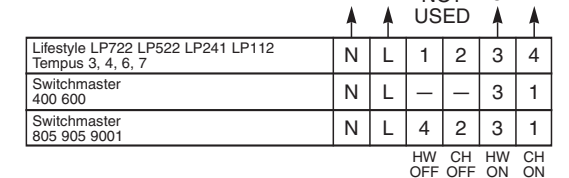

Mains Input 230V 50HZ

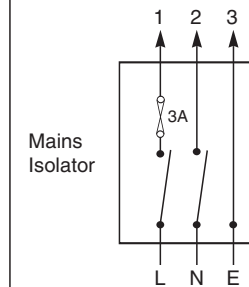

Motorised Valves

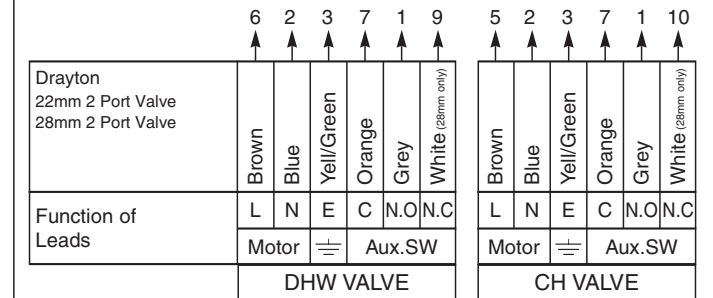

The white wire (28mm Valves) becomes live when the valve closes, it is not used and is wired to 'spare' terminals for safe isolation.

Every effort has been made to simplify the instructions and to ensure accuracy. However, the information is provided for guidance only and Invensys Controls Europe are unable to accept liability for incorrect installation.

WHERE ANY DOUBT EXISTS, PLEASE SEEK PROFESSIONAL ADVICE

